

7 DEALER MANUAL FOR DP C10.CAN



CONTENT

7.1 Important Notice	2	7.7.2 Selection of Support Levels.....	6
7.2 Introduction of Display	2	7.7.3 Selection mode.....	7
7.3 Product Description	3	7.7.4 Headlights / backlighting.....	7
7.3.1 Specifications.....	3	7.7.5 Walk Assistance.....	8
7.3.2 Functions Overview.....	3	7.7.6 Battery capacity indication.....	8
7.4 Display Installation	4	7.7.7 USB charge function.....	8
7.5 Display	5	7.8 Settings	9
7.6 Key Definition	6	7.8.1 Setting.....	9
7.7 Normal Operation	6	7.8.2 View Information.....	11
7.7.1 Switching the System ON/OFF.....	6	7.9 Error Code Definition	15

7.1 IMPORTANT NOTICE

- If the error information from the display cannot be corrected according to the instructions, please contact your retailer.
- The product is designed to be waterproof. It is highly recommended to avoid submerging the display under water.
- Do not clean the display with a steam jet, high-pressure cleaner or water hose.
- Please use this product with care.
- Do not use thinners or other solvents to clean the display. Such substances can damage the surfaces.
- Warranty is not included due to wear and normal use and aging.

7.2 INTRODUCTION OF DISPLAY

- Model: DP C10.CAN BUS
- The housing material is PC and Acrylic, and the button material is made of silicone.
- The label marking is as follows:



- **Note:** Please keep the QR code label attached to the display cable. The information from the Label is used for a later possible software update.

7.3 PRODUCT DESCRIPTION

7.3.1 Specifications

- Operating temperature: -20 °C~45 °C
- Storage temperature: -20 °C~50 °C
- Waterproof: IP65
- Bearing humidity: 30%-70% RH

7.3.2 Functional Overview

- Speed display (including speed in real time (SPEED), top speed (MAXS) and average speed (AVG), switching between km and miles)
- Switching between km and miles
- Battery capacity indicator
- Automatic sensors explanation of the lighting system
- Brightness setting for backlight
- Indication of performance support
- Walk assistance
- Kilometer stand (including single-trip distance, total distance)
- Display for the remaining distance.(Depends on your riding style)
- Motor output power indicator
- Energy consumption indicator CALORIES (Note: If the display has this function)
- Error messages view
- Service
- USB charge function

7.4 DISPLAY INSTALLATION

1. Open the clamps of display and insert the rubber rings A on the handlebar. (it is suitable for handlebar \varnothing 22.2 or \varnothing 31.8)

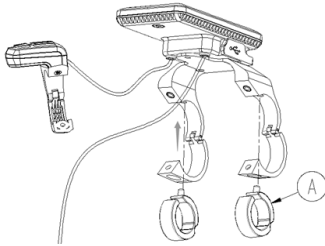

2. Now place the display on to the handlebar in the correct position, with two M4*8 screws (C), tighten the display (B the clamps) into position. Torque requirement: 1N.m.

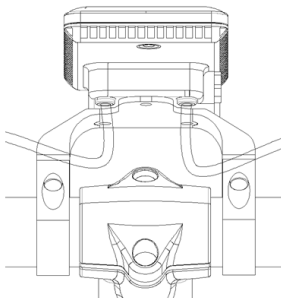
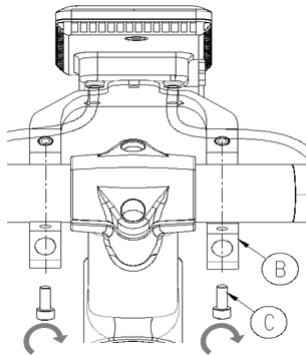

3. Open the clamp (D) on the controller pad and place it in the correct position (it is suitable for handlebar: \varnothing 22.2).

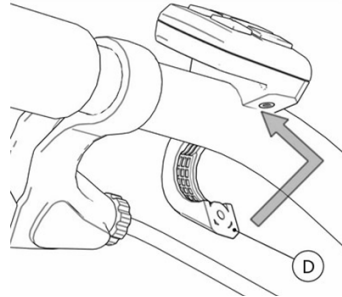

4. Using a M3*10 screw (E) tighten the controller pad onto the handlebar. Torque requirement: 1N.m.

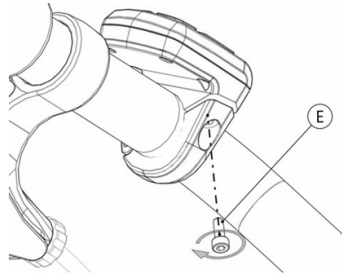

5. Please link the display to the EB-BUS cable.
h: The male connector from display.
H: The female connector from EB-BUS.

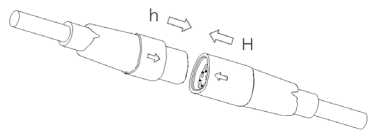

7.5 DISPLAY

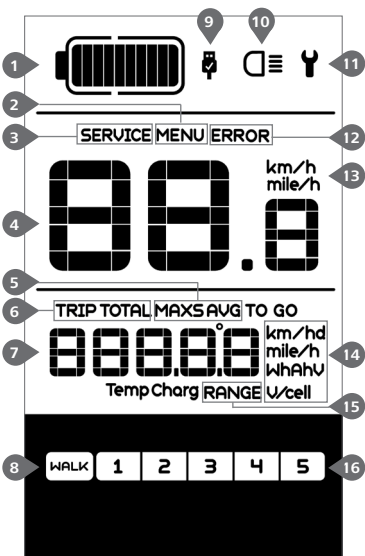

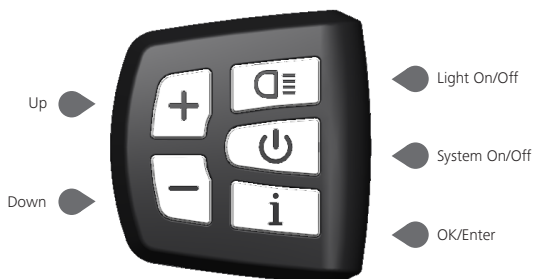

- 1 Display of battery capacity in real time.
- 2 Menu.
- 3 Service: please see the service section.
- 4 Digital speed display.
- 5 Speed mode , top speed (MAXS) - Average speed (AVG).
- 6 Kilometer stand, Daily kilometers (TRIP) - Total kilometers (TOTAL).
- 7 Data: Display data, which corresponds to the current mode.
- 8 Walking assistance **WALK** .
- 9 USB charging indicator displays the icon  , if an external USB device is connected to the display.
- 10 The display shows **0** this symbol, if the light is on.
- 11 Error indicator **Y** .
- 12 Error code indicator.
- 13 Speed unit.
- 14 Unit indicator.
- 15 Remaining distance (RANGE).
- 16 Support level

7.6 KEY DEFINITION





7.7 NORMAL OPERATION

7.7.1 Switching the System ON/OFF

Press and hold (>2S)  on the display to turn on the system. Press and hold (>2S)  again to turn off the system.

If the "automatic shutdown time" is set to 5 minutes (it can be set with the "Auto Off" function, See "Auto Off"), the display will automatically be turned off within the desired time when it is not in operation.

7.7.2 Selection of Support Levels

When the display is turned on, press (<0.5S) the  or  button to switch to the support level, the lowest level is 1, the highest level is 5. When the system is switched on, the support level starts in level 1. There is no support at level null.



7.7.3 Selection mode

Briefly press (<0.5s) the  button to see the different trip modes. Trip: daily kilometers (TRIP) - total kilometers (TOTAL) - Maximum speed (MAXS) - Average speed (AVG) - Remaining distance (RANGE) - Output power (W) - Energy consumption (C (only with torque sensor fitted)).

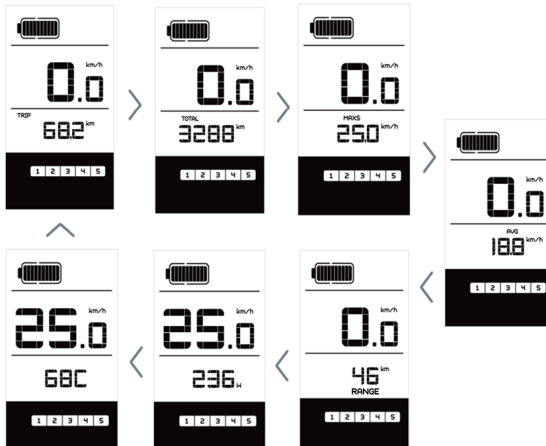

7.7.4 Headlights / backlighting



Hold (>2S) the  button to activate the headlight and backlight.

Hold (>2S) the  button again to turn off the headlight and backlight. The brightness of the backlight can be set in the display settings "Brightness". (If the display /Pedelec is switched on in a dark environment, the display backlight/headlight will automatically be switched on. If the display backlight/headlight has been manually switched off, the automatic sensor function is deactivated. You can only turn on the light manually after switching on the system again.)



7.7.5 Walk Assistance

The Walk assistance can only be activated with a standing pedelec.

Activation: Briefly press (<0.5s) the  button until to level null, and then press (<0.5s) the  button, the **WALK** symbol is displayed. Now hold down the  button and the Walk assistance will activate. The **WALK** symbol will flash and the pedelec moves approx. 6 km/h. After releasing the button, the motor stops automatically and switches back to level null (if no any option be activated in 5 second). If no speed signal is detected, it shows 2.5km/h.

7.7.6 Battery capacity indication

The battery capacity is showed in ten bars. Each full bar represents a remaining capacity of the battery in a percentage, if the frame of indicator blinks that means to charge. (as shown in the figure below):



Bars	Charge in Percentage
10	≥90%
9	80%≤C<90%
8	70%≤C<80%
7	60%≤C<70%
6	50%≤C<60%
5	40%≤C<50%
4	30%≤C<40%
3	20%≤C<30%
2	10%≤C<20%
1	5%≤C<10%
Blinking	C<5%

7.7.7 USB charge function

If an external USB device is connected to the display, the icon  appears, the device will be charged. The maximum charging voltage is 5V and the maximum charging current is 500mA.

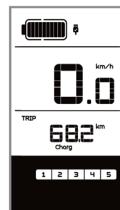

7.8 SETTINGS

After the display is turned on, quickly press (<0.3S) the **i** button twice to access the "MENU" interface. pressing the **+** or **-** button, you can select and reset the options. Then press (<0.3S) the **i** button twice to confirm your selected option and to return to the main screen. If no button is pressed within 10 seconds in "MENU" interface, the display will automatically return to the main screen and no data will be saved.

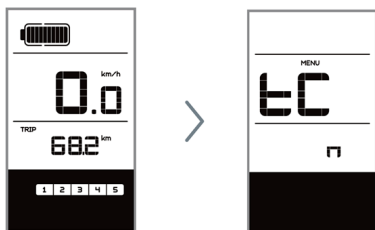

7.8.1 Setting

7.8.1.1 Reset mileage

When the system is on, quickly press (<0.3S) the **i** button twice to access the "MENU" interface and "tC" appears on the display (as shown below). Now using the **+** or **-** button, choose between "y"(YES) or "n"(NO). If choose "y", the Daily kilometers (TRIP), Maximum speed (MAX) and Average speed (AVG) will be reset.

Once you have chosen your desired selection, press (<0.3S) the **i** button twice to save and return to the main screen, or you can press (<0.3S) the **i** button once to save and enter next item "Selection of unit in km/Miles".



NOTE: If the daily kilometers accumulate 99999km, the daily kilometers will be reset automatically.

7.8.1.2 Selection of unit in km/Miles

When the system is on, quickly press (<0.3S) the **i** button twice to access the "MENU" interface, repetitively press the **i** button until the "S7" appears on the display (as shown below). Now using the **+** or **-** button, choose between "km/h" or "mile/h".

Once you have chosen your desired selection, press (<0.3S) the **i** button twice to save and return to the main screen, or you can press (<0.3S) the **i** button once to save and enter next item "Set light sensitivity".



7.8.1.3 Set light sensitivity

When the system is on, quickly press (<0.3S) the **i** button twice to access the "MENU" interface, repetitively press the **i** button until the "bL0" appears on the display (as shown below). And then press **+** to increase or **-** to reduce (light

sensitivity for 0-5). Chose 0 means turn off the light sensitivity.

Once you have chosen your desired selection, press (<0.3S) the **i** button twice to save and return to the main screen, or you can press (<0.3S) the **i** button once to save and enter next item "Set display brightness".



7.8.1.4 Set display brightness

When the system is on, quickly press (<0.3S) the **i** button twice to access the "MENU" interface, repetitively press the **i** button until the "bL1" appears on the display (as shown below). And then press **+** to increase or **-** to reduce (brightness for 1-5).

Once you have chosen your desired selection, press (<0.3S) the **i** button twice to save and return to the main screen, or you can press (<0.3S) the **i** button once to save and enter next item "Set Auto Off".



7.8.1.5 Set Auto Off

When the system is on, quickly press (<0.3S) the **i** button twice to access the "MENU" interface, repetitively press the

i button until the "OFF" appears on the display (as shown below). And then press **+** to increase or **-** to reduce (brightness for 1-9minute).

Once you have chosen your desired selection, press (<0.3S) the **i** button twice to save and return to the main screen, or you can press (<0.3S) the **i** button once to save and enter next item "Service Tip".



7.8.1.6 Service Tip

When the system is on, quickly press (<0.3S) the **i** button twice to access the "MENU" interface, repetitively press the **i** button until the "nnA" appears on the display (as shown below). And then press **+** or **-** to choose between "0" or "1". Chose 0 means turn off the notification.

Once you have chosen your desired selection, press (<0.3S) the **i** button twice to save and return to the main screen.







NOTE: If the "Service" function switch on, every 5000 km (the mileage of more than 5000 km) the indicator "SERVICE" is displayed every time at switch on.

7.8.2 View Information

All data in this item cannot be changed, only to be viewed.



7.8.2.1 Wheel Size



When the system is on, quickly press (<0.3S) the  button twice to access the "MENU" interface, repetitively press the  button until the "LUd" appears on the display (as shown below).

Once you have viewed your desired information, press (<0.3S) the  button twice to save and return to the main screen, or you can press (<0.3S) the  button once to enter next item "Speed Limit".





7.8.2.2 Speed Limit

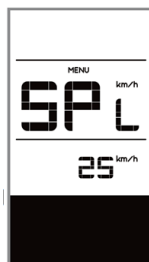

When the system is on, quickly press (<0.3S) the  button twice to access the "MENU" interface, repetitively press the  button until the "SPL" appears on the display (as shown below).

Once you have viewed your desired information, press (<0.3S) the  button twice to save and return to the main screen, or you can press (<0.3S) the  button once to enter next item "Controller hardware info".





7.8.2.3 Controller hardware info

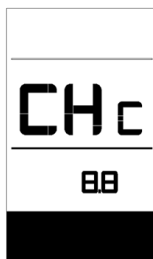

When the system is on, quickly press (<0.3S) the  button twice to access the "MENU" interface, repetitively press the  button until the "CHc (Controller Hardware check)" appears on the display (as shown below).

Once you have viewed your desired information, press (<0.3S) the  button twice to save and return to the main screen, or you can press (<0.3S) the  button once to enter next item "Controller software info".





7.8.2.4 Controller software info



When the system is on, quickly press (<0.3S) the  button twice to access the "MENU" interface, repetitively press the  button until the "CSc (Controller Software check)" appears on the display (as shown below).

Once you have viewed your desired information, press (<0.3S) the  button twice to save and return to the main screen, or you can press (<0.3S) the  button once to enter next item "Display hardware info".



7.8.2.5 Display hardware info

When the system is on, quickly press (<0.3S) the  button twice to access the "MENU" interface, repetitively press the  button until the "dHc (Display Hardware check)" appears on the display (as shown below).



Once you have viewed your desired information, press (<0.3S) the  button twice to save and return to the main screen, or you can press (<0.3S) the  button once to enter next item "Display software info".



7.8.2.6 Display software info



When the system is on, quickly press (<0.3S) the  button twice to access



the "MENU" interface, repetitively press the  button until the "dSc (Display Software check)" appears on the display (as shown below).

Once you have viewed your desired information, press (<0.3S) the  button twice to save and return to the main screen, or you can press (<0.3S) the  button once to enter next item "BMS hardware info".





7.8.2.7 BMS hardware info



When the system is on, quickly press (<0.3S) the  button twice to access the "MENU" interface, repetitively press the  button until the "bHc (BMS Hardware check)" appears on the display (as shown below).

Once you have viewed your desired information, press (<0.3S) the  button twice to save and return to the main screen, or you can press (<0.3S) the  button once to enter next item "BMS software info".





7.8.2.8 BMS software info

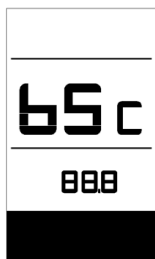

When the system is on, quickly press (<0.3S) the  button twice to access the "MENU" interface, repetitively press the  button until the "dSc (Display Software check)" appears on the display (as shown below).

Once you have viewed your desired information, press (<0.3S) the  button twice to save and return to the main screen, or you can press (<0.3S) the  button once to enter next item "Sensor hardware info".



7.8.2.9 Sensor hardware info



When the system is on, quickly press (<0.3S) the  button twice to access the "MENU" interface, repetitively press the  button until the "SHc (Sensor Hardware check)" appears on the display (as shown below).

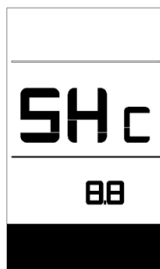

Once you have viewed your desired information, press (<0.3S) the  button twice to save and return to the main screen, or you can press (<0.3S) the  button once to enter next item "Sensor software info".



NOTE: This information is not displayed, if there are no torque sensor in the drive system.

7.8.2.10 Sensor software info

When the system is on, quickly press (<0.3S) the  button twice to access the "MENU" interface, repetitively press the  button until the "SSc (Sensor Software check)" appears on the display (as shown below).

Once you have viewed your desired information, press (<0.3S) the  button twice to save and return to the main screen, or you can press (<0.3S) the  button once to enter next item "Battery info".



NOTE: This information is not displayed, if there are no torque sensor in the drive system.

7.8.2.11 Battery Information

When the system is on, quickly press (<0.3S) the **i** button twice to access the "MENU" interface, repetitively press the **i** button until the "b01" appears on the display (as shown below). You can briefly press **i** (0.3s) to view all information of the battery.

Once you have viewed your desired information, press (<0.3S) the **i** button twice to save and return to the main screen, or you can press (<0.3S) the **i** button once to enter next item "Message of Error Code".

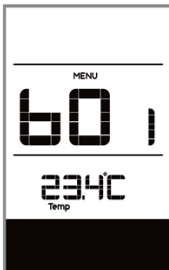

Content	Explanation
b01	Current temperature (°C)
b04	Voltage (V)
b06	Discharge (A)
b07	Remaining Capacity (A/h)
b08	Total Capacity (A/h)
b09	Relative SOC (%)
b10	Absolute SOC (%)

b11	Charging cycles (number)
b12	Maximum not charging time (Hr)
b13	Recently not charging time (Hr)
d00	Number of battery cell
d01	Voltage of cell 1 (mV)
d02	Voltage of cell 2 (mV)
dn	Voltage of cell n (mV)

NOTE: If no data is detected, "--" is displayed.



7.8.2.12 Message of Error Code

When the system is on, quickly press (<0.3S) the **i** button twice to access the "MENU" interface, repetitively press the **i** button until the "E00" appears on the display (as shown below). You can briefly press **i** (0.3s) to view last ten Error Code "E00" to "E09". Error code "00" means that there is no error.

Once you have viewed your desired information, press (<0.3S) the **i** button twice to save and return to the main screen.



7.9 ERROR CODE DEFINITION

 The display can show the errors of a pedelec. If an error is detected, the wrench icon  appears on the display and one of the following error codes will be displayed.

Note: Please read carefully the description of the error code. When the error code appears, please first restart the system. If the problem is not eliminated, please contact your dealer or technical personnel.



Error	Declaration	Troubleshooting
04	The throttle has fault.	<ol style="list-style-type: none"> 1. Check the connector and cable of the throttle are not damaged and correctly connected. 2. Disconnect and reconnect the throttle, if still no function please change the throttle.
05	The throttle is not back in its correct position.	Check the connector from the throttle is correctly connected. If this does not solve the problem, please change the throttle.
07	Overvoltage protection	<ol style="list-style-type: none"> 1. Remove and re-Insert the battery to see if it resolves the problem. 2. Using the BESST tool update the controller. 3. Change the battery to resolve the problem.
08	Error with the hall sensor signal inside the motor	<ol style="list-style-type: none"> 1. Check all connectors from the motor are correctly connected. 2. If the problem still occurs, please change the motor.
09	Error with the Engine phase's	Please change the motor.
10	The temperature inside the engine has reached its maximum protection value	<ol style="list-style-type: none"> 1. Turn off the system and allow the Pedelec to cool down. 2. If the problem still occurs, please change the motor.
11	The temperature sensor inside the motor has an error	Please change the motor.
12	Error with the current sensor in the controller	Please change the controller or contact your supplier.

Error	Declaration	Troubleshooting
13	Error with the temperature sensor inside of the battery	<ol style="list-style-type: none"> 1. Check all connectors from the battery are correctly connected to the motor. 2. If the problem still occurs, please change the Battery.
14	The protection temperature inside the controller has reached its maximum protection value	<ol style="list-style-type: none"> 1. Allow the pedelec to cool down and restart the system. 2. If the problem still occurs, please change the controller or contact your supplier.
15	Error with the temperature sensor inside the controller	<ol style="list-style-type: none"> 1. Allow the pedelec to cool down and restart the system. 2. If the problem still occurs, Please change the controller or contact your supplier.
21	Speed sensor Error	<ol style="list-style-type: none"> 1. Restart the system 2. Check that the magnet attached to the spoke is aligned with the speed sensor and that the distance is between 10 mm and 20 mm. 3. Check that the speed sensor connector is connected correctly. 4. Connect the pedelec to BESST, to see if there is a signal from the speed sensor. 5. Using the BESST Tool- update the controller to see if it resolves the problem. 6. Change the speed sensor to see if this eliminates the problem. If the problem still occurs, please change the controller or contact your supplier.
25	Torque signal Error	<ol style="list-style-type: none"> 1. Check that all connections are connected correctly. 2. Please connect the pedelec to the BESST system to see if torque can be read by the BESST tool. 3. Using the BESST Tool update the controller to see if it resolves the problem, if not please change the torque sensor or contact your supplier.

Error	Declaration	Troubleshooting
26	Speed signal of the torque sensor has an error	<ol style="list-style-type: none"> 1. Check that all connections are connected correctly. 2. Please connect the pedelec to the BESST system to see if speed signal can be read by the BESST tool. 3. Change the Display to see if the problem is solved. 4. Using the BESST Tool update the controller to see if it resolves the problem, if not please change the torque sensor or contact your supplier.
27	Overcurrent from controller	Using the BESST tool update the controller. If the problem still occurs, please change the controller or contact your supplier.
30	Communication problem	<ol style="list-style-type: none"> 1. Check all connections on the pedelec are correctly connected. 2. Using the BESST Tool run a diagnostics test, to see if it can pinpoint the problem. 3. Change the display to see if the problem is solved. 4. Change the EB-BUS cable to see if it resolves the problem. 5. Using the BESST tool, re-update the controller software. If the problem still occurs please change the controller or contact your supplier.
33	Brake signal has an error (If brake sensors are fitted)	<ol style="list-style-type: none"> 1. Check all connectors are correctly connected on the brakes. 2. Change the brakes to see if the problem is solved. <p>If problem continues Please change the controller or contact your supplier.</p>
35	Detection circuit for 15V has an error	Using the BESST tool update the controller to see if this resolves the problem. If not, please change the controller or contact your supplier.
36	Detection circuit on the keypad has an error	Using the BESST tool update the controller to see if this resolves the problem. If not, please change the controller or contact your supplier.

Error	Declaration	Troubleshooting
37	WDT circuit is faulty	Using the BESST tool update the controller to see if this resolves the problem. If not, please change the controller or contact your supplier.
41	Total voltage from the battery is too high	Please change the battery.
42	Total voltage from the battery is too low	Please Charge the battery. If the problem still occurs, please change the battery.
43	Total power from the battery cells is too high	Please change the battery.
44	Voltage of the single cell is too high	Please change the battery.
45	Temperature from the battery is too high	Please let the pedelec cool down. If problem still occurs, please change the battery.
46	The temperature of the battery is too low	Please bring the battery to room temperature. If the problem still occurs, please change the battery.
47	SOC of the battery is too high	Please change the battery.
48	SOC of the battery is too low	Please change the battery.
61	Switching detection defect	1. Check the gear shifter is not jammed. 2. Please change the gear shifter.
62	Electronic derailleur cannot release.	Please change the derailleur.
71	Electronic lock is jammed	1. Using the BESST tool update the Display to see if it resolves the problem. 2. Change the display if the problem still occurs, please change the electronic lock.
81	Bluetooth module has an error	Using the BESST tool, re-update the software onto the display to see if it resolves the problem. If not, Please change the display.